

WIG/TIG Schweißbrenner

TIG Welding torches / Torches de soudage TIG



WIG/TIG Bestellübersicht / Ordering information / Informations commande

Gasgekühlt / Gas cooled / Refroidissement par gaz	4 ... 5
Wassergekühlt / Water cooled / Refroidissement par eau	6 ... 8
Ausführung mit Lamellenschalter / Models with blade switch / Modèles à lamelle	9

Ersatz- und Verschleißteile / Spare parts and consumables / Pièces de rechange et consommables

TBi SR 9, TBi SR 20, TBi SR 21	10 ... 11
TBi SR 17, TBi SR 18, TBi SR 26	12 ... 13
TBi SR 24G, TBi SR 24W	14
TBi SR 25G FX, TBi SR 25W FX	15
TBi AW 424, TBi AW 427	16
TBi SR 400	17
TBi XCT 400W	18
TBi SR 12	20

Griffe und Module / Handles and modules / Poignées et modules

Griffschale Precision / Precision Handle / Poignée Precision	19
Griffrohre und Schalter / Handle tubes and switches / Poignées tubulaires et gâchettes	21
Griffrohre für Ventilbrenner / Handle tubes for torch bodies with / Poignées pour versions à valve	22

Automatenbrenner / Machine Torches / Torches automatiques

Automatenbrenner / Machine Torches / Torches automatiques	23
-----------------------------------------------------------	----

Ausrüstkits / Consumables kit / Kits équipement

Ausrüstkits / Consumables kit / Kits équipement	24
-------------------------------------------------	----

Gasgekühlt /
Gas cooled /
Refroidissement par air



			TBi SR 9 (FX)	TBi SR 17 (FX)	TBi SR 26 (FX)	TBi SR 24G
	M12x1	Standard Standard, FX	415P09 0 413P09 0	415P17 0 413P17 0	415P26 0 413P26 0	415P23 0 -
	G 1/4"	Standard Standard, FX	415P09 2 413P09 2	415P17 2 413P17 2	415P26 2 413P26 2	415P23 2 -
	G 3/8"	Standard Standard, FX	415P09 3 413P09 3	415P17 3 413P17 3	415P26 3 413P26 3	415P23 3 -
	TSB 10/25 (Ø 9 mm)	Standard Standard, FX	415P09 3B 413P09 3B	415P17 3B 413P17 3B	415P26 3B 413P26 3B	415P23 3B -
	TSB 35/50 (Ø 13 mm)	Standard Standard, FX	415P09 3C 413P09 3C	415P17 3C 413P17 3C	415P26 3C 413P26 3C	415P23 3C -
	TSB 10/25 Mono (Ø 9 mm)	Standard Standard, FX	415P09 B 413P09 B	415P17 B 413P17 B	* *	* -
	TSB 35/50 Mono (Ø 13 mm)	Standard Standard, FX	415P09 C 413P09 C	415P17 C 413P17 C	415P26 C 413P26 C	* -
	Euro-W5G	Standard Standard, FX	415P09 Y 413P09 Y	415P17 Y 413P17 Y	415P26 Y 413P26 Y	415P23 Y -
	Euro-GZ	Standard Standard, FX	415P09 9 413P09 9	415P17 9 413P17 9	415P26 8 413P26 8	415P23 9 -

Alle gängigen Maschinenanschlüsse ab Lager lieferbar. Weitere Informationen auf Anfrage. /

Torch connections for all types of power sources are on stock. More information on request. /

Tous types de raccords courant disponibles. Informations complémentaires sur demande.

Bitte gewünschtes Schaltermodul angeben /

Please indicate the required switch module /

Merci d'indiquer le module de commande souhaité

C

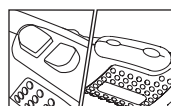

Doppeltaster (Ausführung abhängig vom Brennermodell) /
Double function switch (style depends on torch model) / Double bouton
(version dépendant du modèle de torche)

P

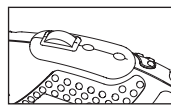

Doppeltaster mit Poti, 10 kΩ /
Double function switch with poti, 10 kΩ / Double bouton et potentiomètre, 10 kΩ

D

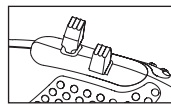

Doppelhebel /
Dual levers / Double levier

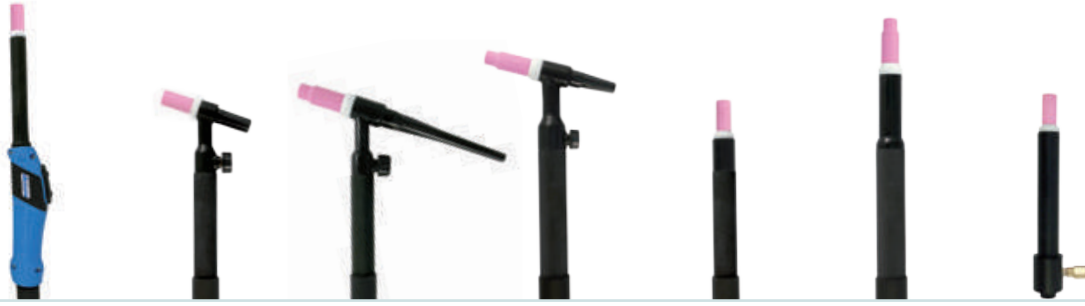

TBi SR 25G FX	TBi SR 9 V (FX)	TBi SR 17 V (FX)	TBi SR 26 V (FX)	TBi SR 9 P (Aut)	TBi SR 26 P (Aut)	TBi Aut 22G
- 413P25 0	405P09V 0 403P09V 0	405P17V 0 403P17V 0	405P26V 0 403P26V 0	491P09700 -	491P26700 -	491P23700 -
- 413P25 2	405P09V 2 403P09V 2	405P17V 2 403P17V 2	405P26V 2 403P26V 2	491P09702 -	491P26702 -	491P23702 -
- 413P25 3	405P09V 3 403P09V 3	405P17V 3 403P17V 3	405P26V 3 403P26V 3	491P09703 -	491P26703 -	491P23703 -
- 413P25 3B	405P09V3B 403P09V3B	405P17V3B 403P17V3B	405P26V3B 403P26V3B	491P0970B -	- -	491P2373B -
- 413P25 3C	405P09V3C 403P09V3C	405P17V3C 403P17V3C	405P26V3C 403P26V3C	491P0970C -	491P2673C -	491P2373C -
- *	* *	* *	* *	* -	* -	491P2371B -
- *	* *	* *	* *	* -	* -	491P2371C -
- 413P25 Y	* *	* *	* *	* -	* -	* -
- 413P25 9	* *	* *	* *	491P09709 -	491P26708 -	* -

Bitte gewünschtes Schlauchpaket angeben /
Please indicate the required cable type /
Merci d'indiquer le type de faisceau souhaité

- 1** Gummiüberzugschlauch (Standard) /
Rubber outer cover (standard) /
Housse faisceau caoutchouc (standard)
- L** Lederüberzugschlauch vorne (ca. 0.6 m), Gummi /
Leather cover in the front (0.6 m), rubber cover /
Housse cuir à l'avant (env. 0,6 m), reste caoutchouc
- T** Textilüberzugschlauch /
Textile outer cover /
Housse faisceau textile

Bitte gewünschte Schlauchpaketlänge angeben /
Please indicate the required cable length /
Merci d'indiquer la longueur de faisceau souhaitée

- 4** 4 m / 12 ft
- 8** 8 m / 25 ft

* Artikelnummer auf Anfrage /
* Part-No. on request /
* Référence des pièces sur demande

Wassergekühlt / Water cooled / Refroidissement par eau



			TBi SR 18 (FX)	TBi SR 20 (FX)	TBi SR 21 (FX)	TBi SR 24W (FX)
	M12x1	Standard	415P18 0	415P20 0	415P21 0	415P24 0
		Standard, FX	413P18 0	413P20 0	413P21 0	413P24 0
	G 1/4"	Standard	415P18 2	415P20 2	415P21 2	415P24 2
		Standard, FX	413P18 2	413P20 2	413P21 2	413P24 2
	G 3/8"	Standard	415P18 3	415P20 3	415P21 3	415P24 3
		Standard, FX	413P18 3	413P20 3	413P21 3	413P24 3
	TSB 35/50 (Ø 13 mm)	Standard	415P18 C	415P20 C	415P21 C	415P24 C
		Standard, FX	413P18 C	413P20 C	413P21 C	413P24 C
	Euro-W5W	Standard	415P18 Y	415P20 Y	415P21 Y	415P24 Y
		Standard, FX	413P18 Y	413P20 Y	413P21 Y	413P24 Y
	Euro-WZ-0	Standard	415P18 5	415P20 5	415P21 5	415P24 5
		Standard, FX	413P18 5	413P20 5	413P21 5	413P24 5

Alle gängigen Maschinenanschlüsse ab Lager lieferbar. Weitere Informationen auf Anfrage. /

Torch connections for all types of power sources are on stock. More information on request. /

Tous types de raccords courant disponibles. Informations complémentaires sur demande.

Bitte gewünschtes Schaltermodul angeben /

Please indicate the required switch module /

Merci d'indiquer le module de commande souhaité

C

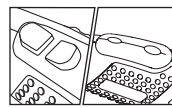

Doppeltaster (Ausführung abhängig vom Brennermodell) /
Double function switch (style depends on torch model) / Double bouton (version dépendant du modèle de torche)

P

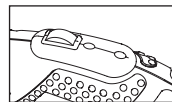

Doppeltaster mit Poti, 10 kΩ /
Double function switch with poti, 10 kΩ / Double bouton et potentiomètre, 10 kΩ

D

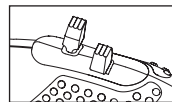

Doppelhebel /
Dual levers / Double levier



TBi SR 25W FX	TBi AW 424	TBi AW 427	TBi SR 400	TBi XCT 400W	TBi SR 12	TBi SR 18 V (FX)	TBi SR 20 V (FX)
- 401P25 0	414P24 0 -	404P27 0 -	415P40 0 -	415PX4 0 -	405P12R 0 -	405P18V 0 403P18V 0	405P20V 0 403P20V 0
- 401P25 2	414P24 2 -	404P27 2 -	415P40 2 -	415PX4 2 -	405P12R12 -	405P18V 2 403P18V 2	405P20V 2 403P20V 2
- 401P25 3	414P24 3 -	404P27 3 -	415P40 3 -	415PX4 3 -	405P12R13 -	405P18V 3 403P18V 3	405P20V 3 403P20V 3
- 401P25 C	414P24 C -	404P27 C -	415P40 C -	415PX4 C -	405P12R1C -	405P18V C 403P18V C	405P20V C 403P20V C
- 401P25 Y	414P24 Y -	404P27 Y -	415P40 Y -	415PX4 Y -	405P12R1Y -	405P18V Y 403P18V Y	405P20V Y 403P20V Y
- 401P25 5	414P24 5 -	404P27 5 -	415P40 5 -	415PX4 5 -	405P12R15 -	405P18V 5 403P18V 5	405P20V 5 403P20V 5

Bitte gewünschtes Schlauchpaket angeben /
Please indicate the required cable type /
Merci d'indiquer le type de faisceau souhaité

- 1** Gummiüberzugschlauch (Standard) /
Rubber outer cover (standard) /
Housse faisceau caoutchouc (standard)
- L** Lederüberzugschlauch vorne (ca. 0.6 m), Gummi /
Leather cover in the front (0.6 m), rubber cover /
Housse cuir à l'avant (env. 0.6 m), reste caoutchouc
- T** Textilüberzugschlauch /
Textile outer cover /
Housse faisceau textile

Bitte gewünschte Schlauchpaketlänge angeben /
Please indicate the required cable length /
Merci d'indiquer la longueur de faisceau souhaitée

- 4** 4 m / 12 ft
- 8** 8 m / 25 ft

Wassergekühlt / Water cooled / Refroidissement par eau



			TBi SR 18 P (Aut)	TBi SR 20 P (Aut)	TBi Aut 22W
	M12x1	Standard	491P18700	491P20700	491P22700
	G 1/4"	Standard	491P18702	491P20702	491P22702
	G 3/8"	Standard	491P18703	491P20703	491P22703
	TSB 35/50 (Ø 13 mm)	Standard	491P1870C	491P2070C	491P2270C
	Euro-W5W	Standard	491P1870Y	491P2070Y	491P2270Y
	Euro-WZ-0	Standard	491P18705	491P20705	491P22705

Alle gängigen Maschinenanschlüsse ab Lager lieferbar. Weitere Informationen auf Anfrage. /

Torch connections for all types of power sources are on stock. More information on request. /

Tous types de raccords courant disponibles. Informations complémentaires sur demande.

Bitte gewünschte Schlauchpaketlänge angeben /
Please indicate the required cable length /
Merci d'indiquer la longueur de faisceau souhaitée

4 4 m / 12 ft

8 8 m / 25 ft

Ausführung mit Lamellenschalter / Models with blade switch / Modèles à lamelle

Gasgekühlt / Gas cooled / Refroidissement par air

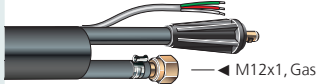
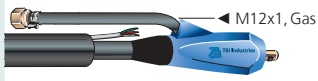

			TBi SR 9 (FX)	TBi SR 17 (FX)	TBi SR 26 (FX)	TBi SR 24G
	TSB 35/50 (Ø 13 mm)	Standard Standard, FX	405P917 1 403P917 1	405P917 2 403P917 2	405P917 5 403P917 5	405P917 7 -
	TSB 35/50 Mono (Ø 13 mm)	Standard Standard, FX	405P91761 403P91761	405P91762 403P91762	405P91765 403P91765	405P91767 -

Wassergekühlt / Water cooled / Refroidissement par eau

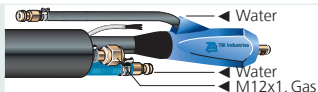

			TBi SR 18 (FX)	TBi SR 20 (FX)	TBi SR 21 (FX)	TBi SR 400	TBi SR 24W (FX)
	TSB 35/50 (Ø 13 mm)	Standard Standard, FX	405P917 3 403P917 3	405P917 4 403P917 4	405P917 9 -	405P917 8 -	405P917 6 403P917 6

Bitte gewünschtes Schlauchpaket angeben /
Please indicate the required cable type /
Merci d'indiquer le type de faisceau souhaité

- 5** Gummiüberzugschlauch (Standard) /
Rubber outer cover (standard) /
Housse faisceau caoutchouc (standard)
- L** Lederüberzugschlauch vorne (ca. 0.6 m), Gummi /
Leather cover in the front (approx. 0.6 m), rubber /
Housse cuir à l'avant (env. 0,6 m), reste caoutchouc
- T** Textilüberzugschlauch /
Textile outer cover /
Housse faisceau textile

Bitte gewünschte Schlauchpaketlänge angeben /
Please indicate the required cable length /
Merci d'indiquer la longueur de faisceau souhaitée

- 4** 4 m / 12 ft
- 8** 8 m / 25 ft

Weitere Modelle auf Anfrage verfügbar /
Other models available on request /
Autres modèles disponibles sur demande

TBi SR 25G,
TBi SR 25W,
TBi AW 424,
TBi AW 428



Hinweis / Note / Avis

Bitte beachten Sie bei den Modellen TBi SR 18, TBi SR 26 und TBi SR 400, dass sich der Brennerkörper von der Version mit Precision-Griff unterscheidet /
Please note that the torch body for models TBi SR 18, TBi SR 26 and TBi SR 400 is different from the torch body for the Precision handle /
Merci de prendre en compte que le corps de torche des modèles TBi SR 18, TBi SR 26 et TBi SR 400, se différencie du corps de torche de la version à poignée Precision.

TBi SR 9 , TBi SR 20 , TBi SR 21



TBi SR 9 (FX)

Gasgekühlt /
gas cooled / refroidissement par air
60% (10 min.)
AC: 80 A
DC: 110 A
Ø 0.5-1.6 mm



TBi SR 20 (FX)

wassergekühlt /
water cooled / refroidissement par eau
100% (10 min.)
AC: 160 A
DC: 220 A
Ø 0.5-3.2 mm



TBi SR 21 (FX)

wassergekühlt /
water cooled / refroidissement par eau
100% (10 min.)
AC: 240 A
DC: 340 A
Ø 0.5-3.2 mm

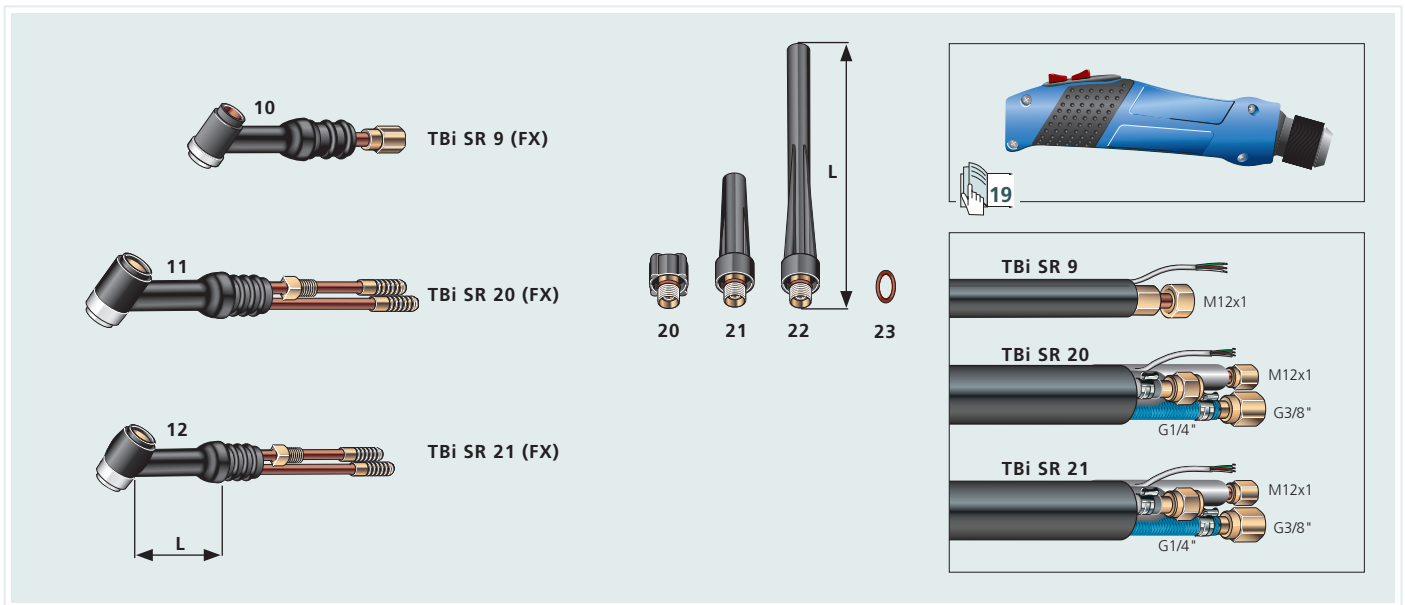

Ersatzteile / Spare parts / Pièces de rechange

10	Brennerkörper / Torch body / Corps de torche	SR 9		L = 35 mm	405P090800
10	Brennerkörper / Torch body / Corps de torche	SR 9 FX (Standard)	flexibel / flexible / flexible	L = 35 mm	403P090800
10	Brennerkörper / Torch body / Corps de torche	SR 9 FX-L	flexibel / flexible / flexible	L = 115 mm	403P090805
11	Brennerkörper / Torch body / Corps de torche	SR 20		L = 35 mm	405P200800
11	Brennerkörper / Torch body / Corps de torche	SR 20 FX (Standard)	flexibel / flexible / flexible	L = 35 mm	403P200700
11	Brennerkörper / Torch body / Corps de torche	SR 20 FX-L	flexibel / flexible / flexible	L = 70 mm	403P200850
11	Brennerkörper / Torch body / Corps de torche	SR 20 FX-LL	flexibel / flexible / flexible	L = 90 mm	403P200750
11	Brennerkörper / Torch body / Corps de torche	SR 20 FX-XL	flexibel / flexible / flexible	L = 115 mm	403P200800
12	Brennerkörper / Torch body / Corps de torche	SR 21		L = 35 mm	405P210800
12	Brennerkörper / Torch body / Corps de torche	SR 21 FX (Standard)	flexibel / flexible / flexible	L = 65 mm	403P210700
12	Brennerkörper / Torch body / Corps de torche	SR 21 FX-L	flexibel / flexible / flexible	L = 115 mm	403P210701
20	Brennerkappe / Back cap / Coiffe	kurz / short / courte		L = 18 mm	41V33 401P200100
21	Brennerkappe / Back cap / Coiffe	mittel / medium / moyenne		L = 48 mm	41V35 401P200200
22	Brennerkappe / Back cap / Coiffe	lang / long / longue		L = 145 mm	41V24 401P200300
23	O-Ring / O-Ring / Joint torique				98W77 365P200046

Verschleißteile / Consumables / Consommables

▶ A	Isolator / Insulator / Isolateur	Standard	598882	402P200900
B	Adapter / Adapter / Adaptateur	Jumbo Gaslinse / Jumbo Gas lens / Diffuseur gaz jumbo	54N63-20	401P200905

▶ = Standard

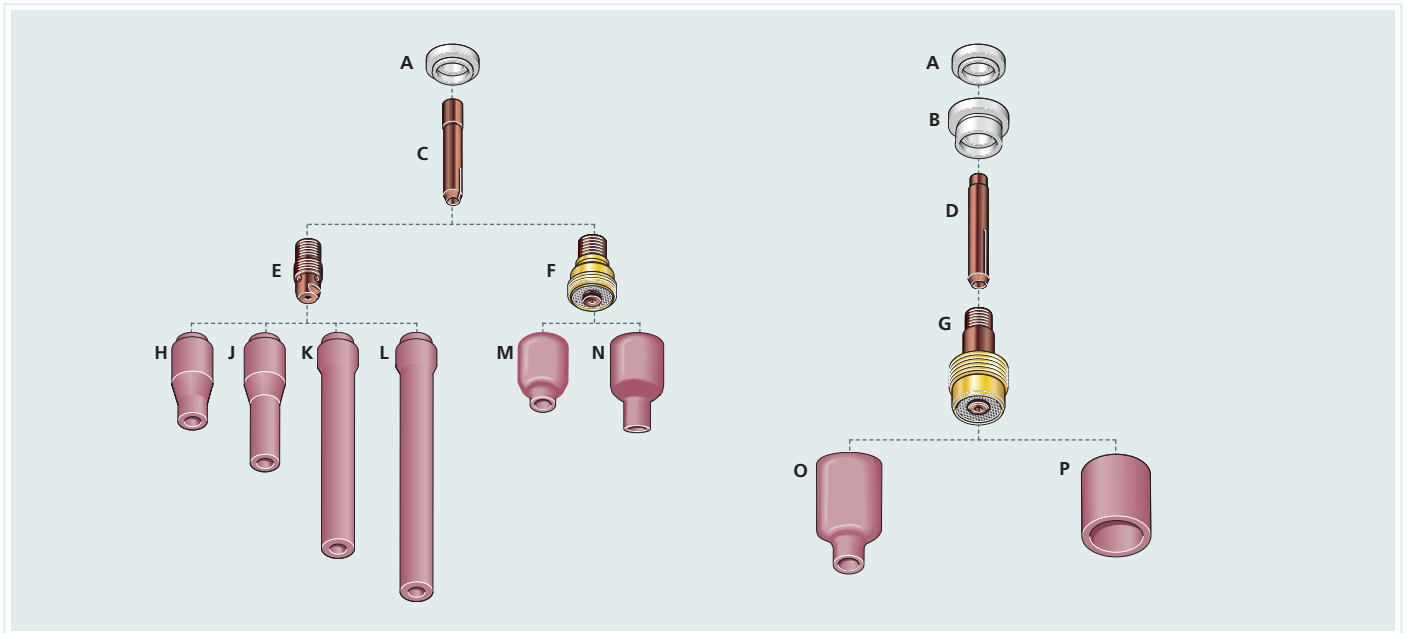

		Ø 0.5 mm Ø 0.020"	Ø 1.0 mm Ø 0.040"	Ø 1.6 mm Ø 1/16"	Ø 2.0 mm	Ø 2.4 mm Ø 3/32"	Ø 3.0 mm	Ø 3.2 mm Ø 1/8"
Spannhülsen / Collets / Pincés étau								
▶ C	Standard, L=25.4 mm	13N20 401P200599	13N21 401P200600	13N22 401P200601	- 401P200604	13N23 401P200602	- 401P200605	13N24 401P200603
D	Jumbo, L=40.1 mm	-	13N21L 401P13N21L	13N22L 401P13N22L	-	13N23L 401P13N23L	-	13N24L 401P13N24L
Spannhülsegehäuse / Collet bodies / Supports pince								
▶ E	L=20.6 mm	13N25 401P200999	13N26 401P201000	13N27 401P201001	- 401P201005	13N28 401P201002	- 401P201006	13N29 401P201003
Gaslinsen / Gas lenses / Diffuseurs gaz								
F	Standard, L=21.5 mm	-	45V42 401P201300	45V43 401P201301	- 401P201304	45V44 401P201302	- 401P201305	45V45 401P201303
G	Jumbo, L=40.5 mm	-	45V0204S 401P201350	45V116S 401P201351	-	45V64S 401P201352	-	995795S 401P201353

		No. 3 Ø 5.0 mm Ø 3/16"	No. 4 Ø 6.5 mm Ø 1/4"	No. 5 Ø 8.0 mm Ø 5/16"	No. 6 Ø 9.5 mm Ø 3/8"	No. 7 Ø 11 mm Ø 7/16"	No. 8 Ø 12.5 mm Ø 1/2"	No. 10 Ø 16 mm Ø 5/8"
Keramische Gasdüsen / Ceramic nozzles / Buses gaz céramiques								
▶ H	Standard, L=30.0 mm	-	13N08 401P201106	13N09 401P201107	13N10 401P201108	13N11 401P201109	13N12 401P201110	13N13 401P201111
J	Standard, L, L=48.0 mm	796F70 401P201115	796F71 401P201116	796F72 401P201117	796F73 401P201118	-	-	-
K	Standard, XL, L=63.0 mm	-	796F75 401P201126	796F76 401P201127	796F77 401P201128	-	-	-
L	Standard, XXL, L=89.0 mm	-	796F79 401P201136	-	-	-	-	-

		No. 4 Ø 6.5 mm Ø 1/4"	No. 5 Ø 8.0 mm Ø 5/16"	No. 6 Ø 9.5 mm Ø 3/8"	No. 7 Ø 11 mm Ø 7/16"	No. 8 Ø 12.5 mm Ø 1/2"	No. 10 Ø 16 mm Ø 5/8"	No. 12 Ø 19 mm Ø 3/4"	Ø 24 mm
Keramische Gasdüsen / Ceramic nozzles / Buses gaz céramiques									
M	Gas lens, L=25.5 mm	53N58 401P201400	53N59 401P201401	53N60 401P201402	53N61 401P201403	53N61S 401P201404	-	-	-
N	Gas lens, L, L=35.0 mm	53N58L 401P201408	53N59L 401P201405	53N60L 401P201406	53N61L 401P201407	-	-	-	-
O	Jumbo Gas lens L=48.0 mm	-	-	57N75 401P201451	-	57N74 401P201452	53N88 401P222250	53N87 401P222251	53N89-L 401P222253
P	Jumbo Gas lens (short), L=34.0 mm	-	-	-	-	-	-	-	53N89 401P222252

▶ = Standard

TBi SR 17 , TBi SR 18 , TBi SR 26



TBi SR 17 (FX)
 Gasgekühlt /
 gas cooled / refroidissement par air
 60% (10 min.)
 AC: 100 A
 DC: 140 A
 Ø 0.5-2.4 mm



TBi SR 18 (FX)
 wassergekühlt /
 water cooled / refroidissement par eau
 100% (10 min.)
 AC: 225 A
 DC: 320 A
 Ø 0.5-4.0 mm



TBi SR 26 (FX)
 Gasgekühlt /
 gas cooled / refroidissement par air
 60% (10 min.)
 AC: 170 A
 DC: 240 A
 Ø 0.5-4.0 mm

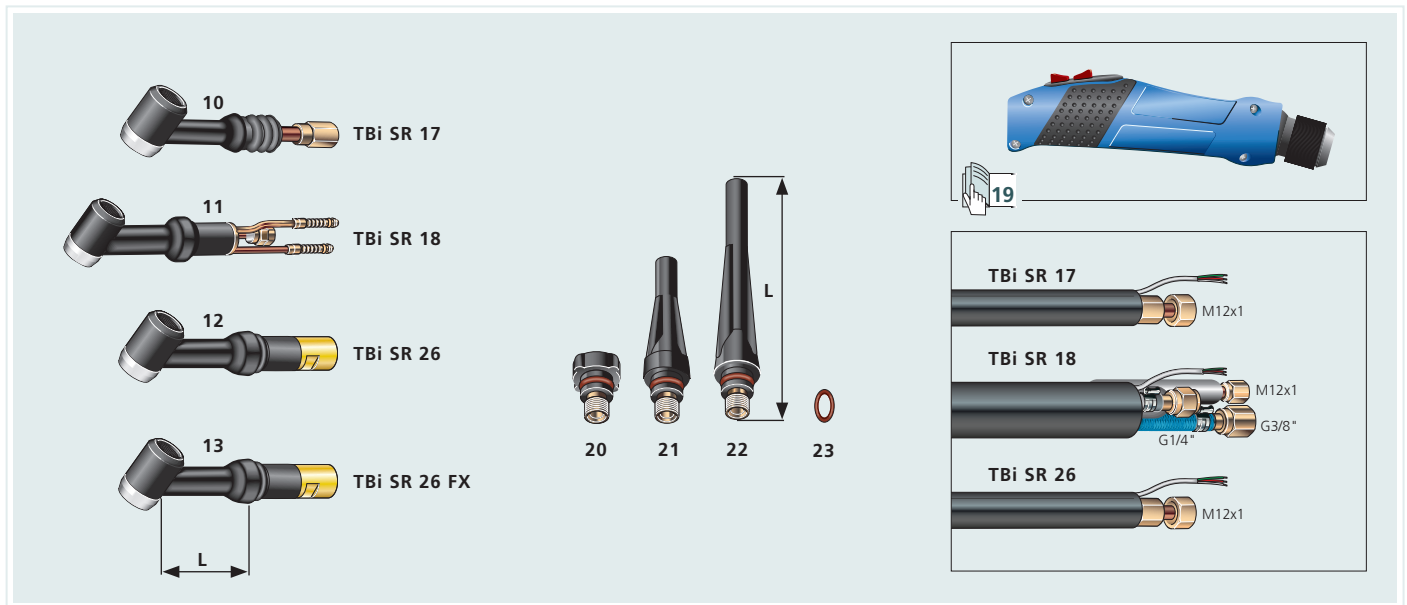

Ersatzteile / Spare parts / Pièces de rechange

10	Brennerkörper / Torch body / Corps de torche	SR 17		L = 50 mm	405P170700
10	Brennerkörper / Torch body / Corps de torche	SR 17 FX	flexibel / flexible / flexible	L = 50 mm	403P170700
11	Brennerkörper / Torch body / Corps de torche	SR 18		L = 50 mm	405P180702
11	Brennerkörper / Torch body / Corps de torche	SR 18 FX	flexibel / flexible / flexible	L = 50 mm	403P180702
12	Brennerkörper / Torch body / Corps de torche	SR 26		L = 50 mm	405P260702
13	Brennerkörper / Torch body / Corps de torche	SR 26 FX	flexibel / flexible / flexible	L = 50 mm	403P260702
20	Brennerkappe / Back cap / Coiffe	kurz / short / courte		L = 24 mm	57Y04 402P170100
21	Brennerkappe / Back cap / Coiffe	mittel / medium / moyenne		L = 58 mm	57Y05 402P170150
22	Brennerkappe / Back cap / Coiffe	lang / long / longue		L = 140 mm	57Y02 402P170200
23	O-Ring / O-Ring / Joint torique				98W18 365P200096

Verschleißteile / Consumables / Consommables

B	Isolator / Insulator / Isolateur	klein, Gaslinse / small, gas lens / diffuseur gaz, petit		402P956100
▶ C	Isolator / Insulator / Isolateur	standard	18CG	403P171000
D	Isolator / Insulator / Isolateur	Gaslinse / Gas lens / Diffuseur gaz	54N01	401P181100
E	Adapter / Adapter / Adaptateur	Jumbo Gaslinse / Jumbo Gas lens / Diffuseur gaz jumbo	54N63	401P171105

▶ = Standard

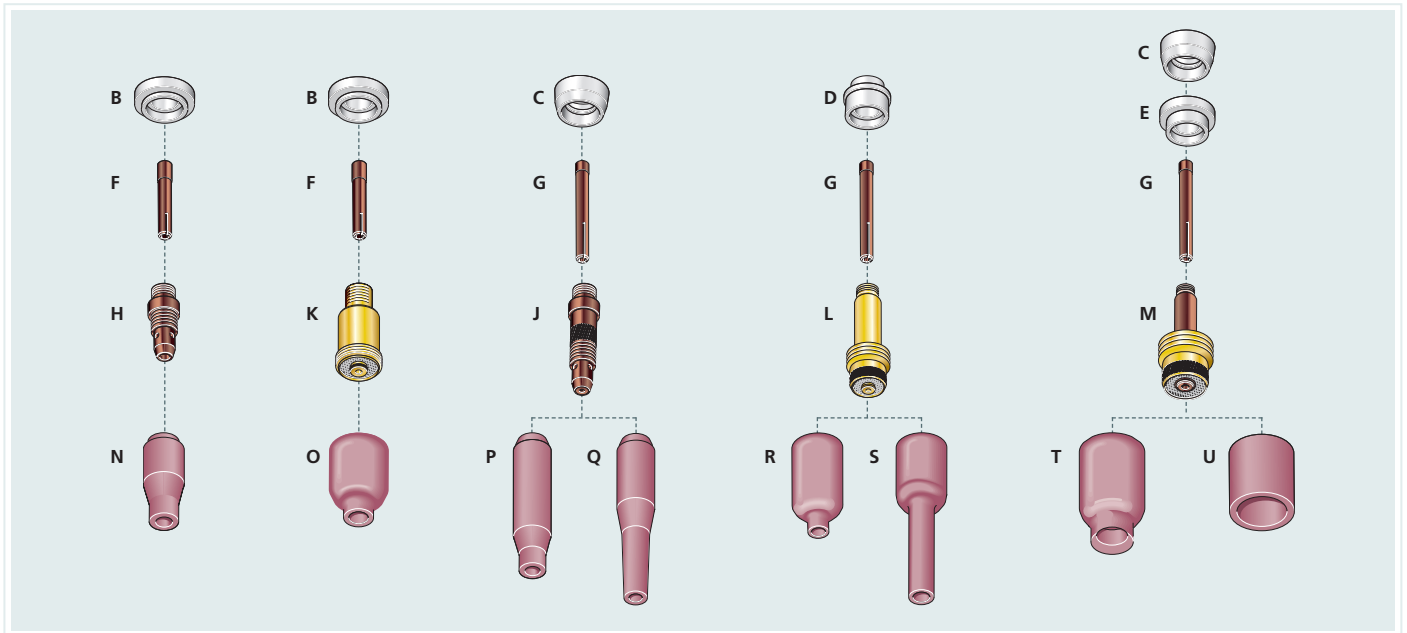

	Ø 0.5 mm Ø 0.020"	Ø 1.0 mm Ø 0.040"	Ø 1.6 mm Ø 1/16"	Ø 2.0 mm	Ø 2.4 mm Ø 3/32"	Ø 3.0 mm	Ø 3.2 mm Ø 1/8"	Ø 4.0 mm Ø 5/32"
--	----------------------	----------------------	---------------------	----------	---------------------	----------	--------------------	---------------------

Spannhülsen / Collets / Pincés étai

F	kurz / short / court L=29.3 mm	-	10N22S 402P10N22S	10N23S 402P10N23S	-	10N24S 402P10N24S	-	10N25S 402P10N25S	-
▶ G	Standard L=50.0 mm	10N21 402P170499	10N22 402P170500	10N23 402P170502	402P170506	10N24 402P170503	402P170507	10N25 402P170504	54N20 402P170505

Spannhülsegehäuse / Collet bodies / Supports pince

H	kurz / short / court L=24.5 mm	-	17CB21 402P17CB21	17CB22 402P17CB22	-	17CB23 402P17CB23	-	17CB24 402P17CB24	-
▶ J	Standard L=47.0 mm	10N29 401P180997	10N30 401P180998	10N31 401P180999	401P181003	10N32 401P181000	401P181004	10N28 401P181001	406488 401P181002

Gaslinsen / Gas lenses / Diffuseurs gaz

K	kurz / short / court L=21.5 mm	-	402P956048	402P956049	-	402P956050	-	402P956051	-
L	Standard L=50.0 mm	-	45V24 401P181299	45V25 401P181300	401P181304	45V26 401P181301	401P181305	45V27 401P181302	45V28 401P181303
M	Jumbo L=50.0 mm	-	45V0204 401P181350	45V116 401P181351	-	45V64 401P181352	-	995795 401P181353	45V63 401P181354

	No. 4 Ø 6.5 mm Ø 1/4"	No. 5 Ø 8.0 mm Ø 5/16"	No. 6 Ø 9.5 mm Ø 3/8"	No. 7 Ø 11 mm Ø 7/16"	No. 8 Ø 12.5 mm Ø 1/2"	No. 10 Ø 16 mm Ø 5/8"	No. 11 Ø 17.5 mm Ø 11/16"	No. 12 Ø 19 mm Ø 3/4"	Ø 24.0 mm
--	-----------------------------	------------------------------	-----------------------------	-----------------------------	------------------------------	-----------------------------	---------------------------------	-----------------------------	-----------

Keramische Gasdüsen / Ceramic nozzles / Buses gaz céramiques

N	kurz/short/court L=30.0 mm	13N08 401P201106	13N09 401P201107	13N10 401P201108	13N11 401P201109	13N12 401P201110	13N13 401P201111	-	-	-
O	Gas lens short L=25.5 mm	53N58 401P201400	53N59 401P201401	53N60 401P201402	53N61 401P201403	53N61S 401P201404	-	-	-	-
▶ P	Standard L=47.0 mm	10N50 401P170907	10N49 401P170908	10N48 401P170909	10N47 401P170910	10N46 401P170911	10N45 401P170912	-	10N44 401P170913*-	-
Q	Standard, L L=76.0 mm	10N50L 401P170923	10N49L 401P170914	10N48L 401P170915	10N47L 401P170916	-	-	-	-	-
R	Gas lens L=42.0 mm	54N18 401P222200	54N17 401P222201	54N16 401P222202	54N15 401P222203	54N14 401P222204	-	54N19 401P222206	-	-
S	Gas lens, L L=76.0 mm	54N18 L 401P222211	54N17 L 401P222207	54N16 L 401P222208	54N15 L 401P222209	54N14 L 401P222210	-	-	-	-
T	Jumbo Gas lens L=48.0 mm	-	-	57N75 401P201451	-	57N74 401P201452	53N88 401P222250	-	53N87 401P222251	53N89-L 401P222253
U	Jumbo Gas lens (short), L=34.0 mm	-	-	-	-	-	-	-	-	53N89 401P222252

* L=50.0 mm

▶ = Standard

TBi SR 24G , TBi SR 24W



TBi SR 24G

Gasgekühlt /
gas cooled / refroidissement par air
60% (10 min.)
AC: 80 A
DC: 110 A
Ø 0.5-1.6 mm

TBi SR 24W (FX)

wassergekühlt /
water cooled / refroidissement par eau
100% (10 min.)
AC: 100 A
DC: 140 A
Ø 0.5-2.4 mm

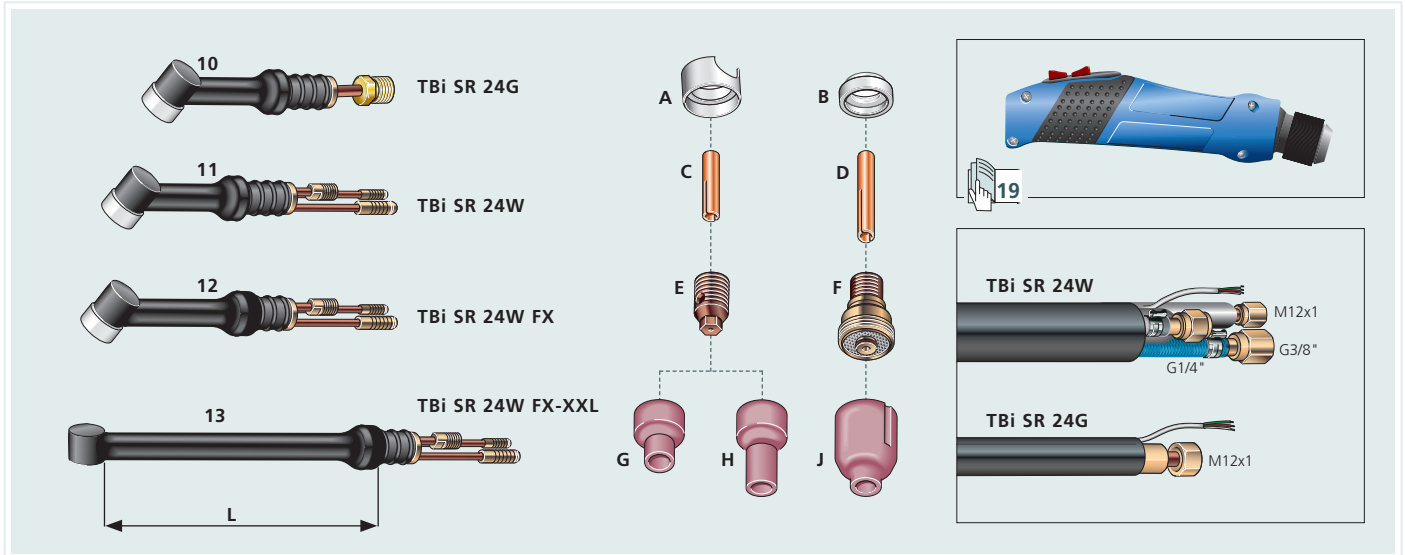

Ersatzteile / Spare parts / Pièces de rechange

10	Brennerkörper / Torch body / Corps de torche	SR 24G		L = 50 mm	405P240800
11	Brennerkörper / Torch body / Corps de torche	SR 24W		L = 50 mm	405P240850
12	Brennerkörper / Torch body / Corps de torche	SR 24W FX (Standard)	flexibel / flexible / flexible	L = 65 mm	403P240700
12	Brennerkörper / Torch body / Corps de torche	SR 24W FX-L	flexibel / flexible / flexible	L = 90 mm	403P240750
12	Brennerkörper / Torch body / Corps de torche	SR 24W FX-XL	flexibel / flexible / flexible	L = 115 mm	403P240701
13	Brennerkörper / Torch body / Corps de torche	SR 24W FX-XXL	flexibel / flexible / flexible	L = 290 mm	403P240770
▶ A	Isolator / Insulator / Isolateur				53N22 401P240700*
B	Isolator / Insulator / Isolateur	Gaslinse / Gas lens / Diffuseur gaz			53N66 401P240701

	Ø 0.5 mm Ø 0.020"	Ø 1.0 mm Ø 0.040"	Ø 1.6 mm Ø 1/16"	Ø 2.4 mm Ø 3/32"
--	----------------------	----------------------	---------------------	---------------------

Spannhülse / Collet / Pincés étou

▶ C	L=14.0 mm	53N15 401P240500	53N16 401P240501	53N14 401P240502	24C332 401P240505
D	Gas lens, L=23.0 mm	-	53N63 401P240802	53N64 401P240803	24GLC332 401P240805

Spannhülsegehäuse / Collet body / Supports pince

▶ E	L=12.0 mm	53N17 401P241000	53N18 401P241001	53N19 401P241002	24CB332 401P241003
-----	-----------	---------------------	---------------------	---------------------	-----------------------

Gaslinsen / Gas lens / Diffuseurs gaz

F	L=21.5 mm	-	45V42 401P201300	45V43 401P201301	45V44 401P201302
---	-----------	---	---------------------	---------------------	---------------------

	No. 4 Ø 6.5 mm Ø 1/4"	No. 5 Ø 8.0 mm Ø 5/16"	No. 6 Ø 9.5 mm Ø 3/8"	No. 7 Ø 11 mm Ø 7/16"	No. 8 Ø 12.5 mm Ø 1/2"
--	-----------------------------	------------------------------	-----------------------------	-----------------------------	------------------------------

Keramische Gasdüsen / Ceramic nozzles / Buses gaz céramiques

▶ G	Standard, L=16.5 mm	53N24 401P240900	53N25 401P240901	53N27 401P240902	-	-
H	Standard, lang / long / longue L=29.0 mm	53N24L 401P240903	-	53N26L 401P240904	-	-
J	Gaslinse / Gas lens / Diffuseur gaz L=25.5 mm	53N58 401P201400	53N59 401P201401	53N60 401P201402	53N61 401P201403	53N61S 401P200404

▶ = Standard * Nicht passend zu Brennerkörper SR 24W FX-XXL / Not compatible with torch body SR 24W FX-XXL / Pas compatible avec corps de torche SR 24W FX-XXL



TBi SR 25G FX

Gasgekühlt /
gas cooled / refroidissement par air
60% (10 min.)
AC: 80 A
DC: 110 A
Ø 0.5-2.4 mm

TBi SR 25W FX

wassergekühlt /
water cooled / refroidissement par eau
100% (10 min.)
AC: 100 A
DC: 140 A
Ø 0.5-3.2 mm

TBi SR 25G FX / TBi SR 25W FX

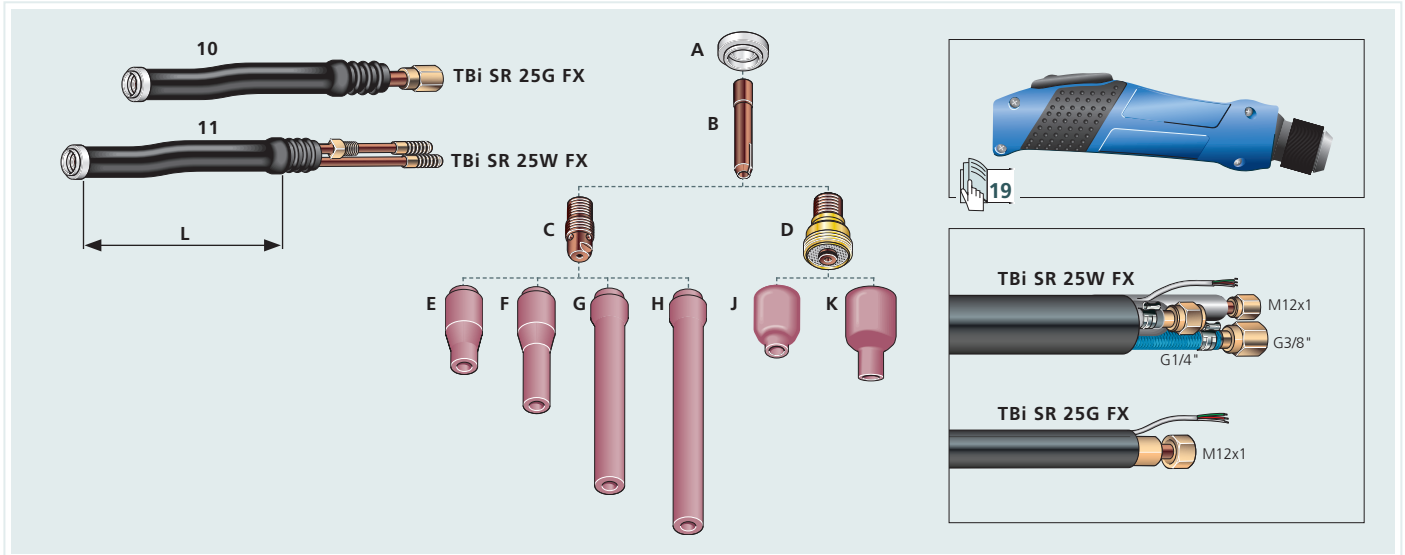

Ersatzteile / Spare parts / Pièces de rechange

10	Brennerkörper / Torch body / Corps de torche	SR 25G FX	flexibel / flexible / flexible	L = 120 mm	401P250200
11	Brennerkörper / Torch body / Corps de torche	SR 25W FX (Standard)	flexibel / flexible / flexible	L = 120 mm	401P251200
11	Brennerkörper / Torch body / Corps de torche	SR 25W FX-L	flexibel / flexible / flexible	L = 300 mm	401P251201
A	Isolator / Insulator / Isolateur			598882-D	401P200950

	Ø 0.5 mm Ø 0.020"	Ø 1.0 mm Ø 0.040"	Ø 1.6 mm Ø 1/16"	Ø 2.0 mm	Ø 2.4 mm Ø 3/32"	Ø 3.0 mm	Ø 3.2 mm Ø 1/8"
--	----------------------	----------------------	---------------------	----------	---------------------	----------	--------------------

Spannhülse / Collet / Pincas étou

▶ B	Standard, L=25.4 mm	13N20 401P200599	13N21 401P200600	13N22 401P200601	- 401P200604	13N23 401P200602	- 401P200605	13N24 401P200603
-----	---------------------	---------------------	---------------------	---------------------	-----------------	---------------------	-----------------	---------------------

Spannhülsegehäuse / Collet body / Supports pince

▶ C	L=20.6 mm	13N25 401P200999	13N26 401P201000	13N27 401P201001	- 401P201005	13N28 401P201002	- 401P201006	13N29 401P201003
-----	-----------	---------------------	---------------------	---------------------	-----------------	---------------------	-----------------	---------------------

Gaslinsen / Gas lens / Diffuseurs gaz

D	L=21.5 mm	-	45V42 401P201300	45V43 401P201301	- 401P201304	45V44 401P201302	- 401P201305	45V45 401P201303
---	-----------	---	---------------------	---------------------	-----------------	---------------------	-----------------	---------------------

	No. 3 Ø 5.0 mm Ø 3/16"	No. 4 Ø 6.5 mm Ø 1/4"	No. 5 Ø 8.0 mm Ø 5/16"	No. 6 Ø 9.5 mm Ø 3/8"	No. 7 Ø 11 mm Ø 7/16"	No. 8 Ø 12.5 mm Ø 1/2"	No. 10 Ø 16 mm Ø 5/8"
--	------------------------------	-----------------------------	------------------------------	-----------------------------	-----------------------------	------------------------------	-----------------------------

Keramische Gasdüsen / Ceramic nozzles / Buses gaz céramiques

▶ E	Standard, L=30.0 mm	-	13N08 401P201106	13N09 401P201107	13N10 401P201108	13N11 401P201109	13N12 401P201110	13N13 401P201111
F	Standard, L, L=48.0 mm	796F70 401P201115	796F71 401P201116	796F72 401P201117	796F73 401P201118	-	-	-
G	Standard, XL, L=63.0 mm	-	796F75 401P201126	796F76 401P201127	796F77 401P201128	-	-	-
H	Standard, XXL, L=89.0 mm	-	796F79 401P201136	-	-	-	-	-
J	Gas lens, L=25.5 mm	-	53N58 401P201400	53N59 401P201401	53N60 401P201402	53N61 401P201403	53N61S 401P201404	-
K	Gas lens, L, L=35.0 mm	-	53N58L 401P201408	53N59L 401P201405	53N60L 401P201406	53N61L 401P201407	-	-

▶ = Standard

TBi AW 424 , TBi AW 427



TBi AW 424

TBi AW 424

wassergekühlt /
water cooled / refroidissement par eau

100% (10 min.)
AC: 280 A
DC: 400 A
Ø 1.0-4.0 mm



TBi AW 427

TBi AW 427

wassergekühlt /
water cooled / refroidissement par eau

100% (10 min.)
AC: 350 A
DC: 500 A
Ø 2.0-8.0 mm

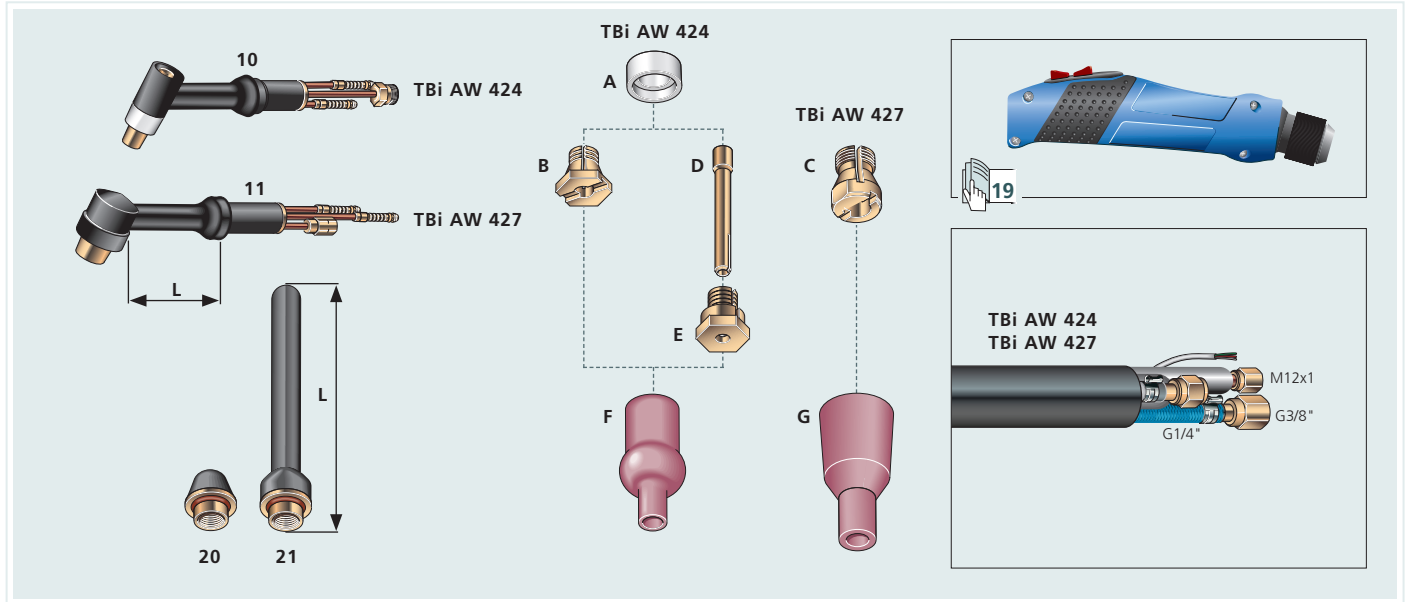

Ersatzteile / Spare parts / Pièces de rechange

10	Brennerkörper / Torch body / Corps de torche	AW 424	L = 55 mm	404P240702
11	Brennerkörper / Torch body / Corps de torche	AW 427	L = 55 mm	404P270702
20	Brennerkappe / Back cap / Coiffe	kurz / short / courte	L = 16 mm	411-30 404P240100
21	Brennerkappe / Back cap / Coiffe	lang / long / longue	L = 101 mm	411-70 404P240200
A	Isolator / Insulator / Isolateur	AW 424	200 NG	404P280300

	Ø 1.0 mm Ø 0.040"	Ø 1.6 mm Ø 1/16"	Ø 2.4 mm Ø 3/32"	Ø 3.2 mm Ø 1/8"	Ø 4.0 mm Ø 5/32"	Ø 4.8 mm Ø 3/16"	Ø 6.4 mm Ø 1/4"	Ø 8.0 mm Ø 5/16"
--	----------------------	---------------------	---------------------	--------------------	---------------------	---------------------	--------------------	---------------------

Spannzange / direct clamping collet / pinces étou simples

B	AW 424, L=10.5 mm	-	221.00 404P240501	222.00 404P240502	223.00 404P240503	224.00 404P240504	-	-
C	AW 427, L=17 mm	-	-	223-07 404P270499	224-07 404P270500	225-07 404P270501	226-07 404P270502	227-07 404P270503
							228-07 404P270504	

Spannhülse / collet / pinces étou

D	AW 424, L=59 mm	964.01 404P240602	965.01 404P240603	966.01 404P240604	967.01 404P240605	968.01 404P240606	-	-
---	--------------------	----------------------	----------------------	----------------------	----------------------	----------------------	---	---

Spannhülsegehäuse / Collet body / Supports pince

E	AW 424, L=10.5 mm	961.41 404P240902	961.51 404P240903	961.61 404P240904	961.71 404P240905	961.81 404P240906	-	-
---	----------------------	----------------------	----------------------	----------------------	----------------------	----------------------	---	---

	No. 4 Ø 6.5 mm Ø 1/4"	No. 5 Ø 8.0 mm Ø 5/16"	No. 6 Ø 9.5 mm Ø 3/8"	No. 7 Ø 11 mm Ø 7/16"	No. 8 Ø 12.5 mm Ø 1/2"	No. 9 Ø 14 mm Ø 9/16"	No. 10 Ø 16 mm Ø 5/8"	Ø 18 mm
--	-----------------------------	------------------------------	-----------------------------	-----------------------------	------------------------------	-----------------------------	-----------------------------	---------

Keramische Gasdüsen / Ceramic nozzles / Buses gaz céramiques

F	Standard, L=44.0 mm	130-00 404P241100	131-00 404P241101	132-00 404P241102	133-00 404P241103	134-00 404P241104	135-00 404P241105	136-00 404P241106	- 404P241108
G	Standard, L=54.0 mm	-	141-00 404P271100	142-00 404P271101	143-00 404P271102	144-00 404P271103	145-00 404P271104	-	-



TBi SR 400
 wassergekühlt /
 water cooled / refroidissement par eau
 100% (10 min.)
 AC: 315 A
 DC: 450 A
 Ø 1.0-4.8 mm

TBi SR 400

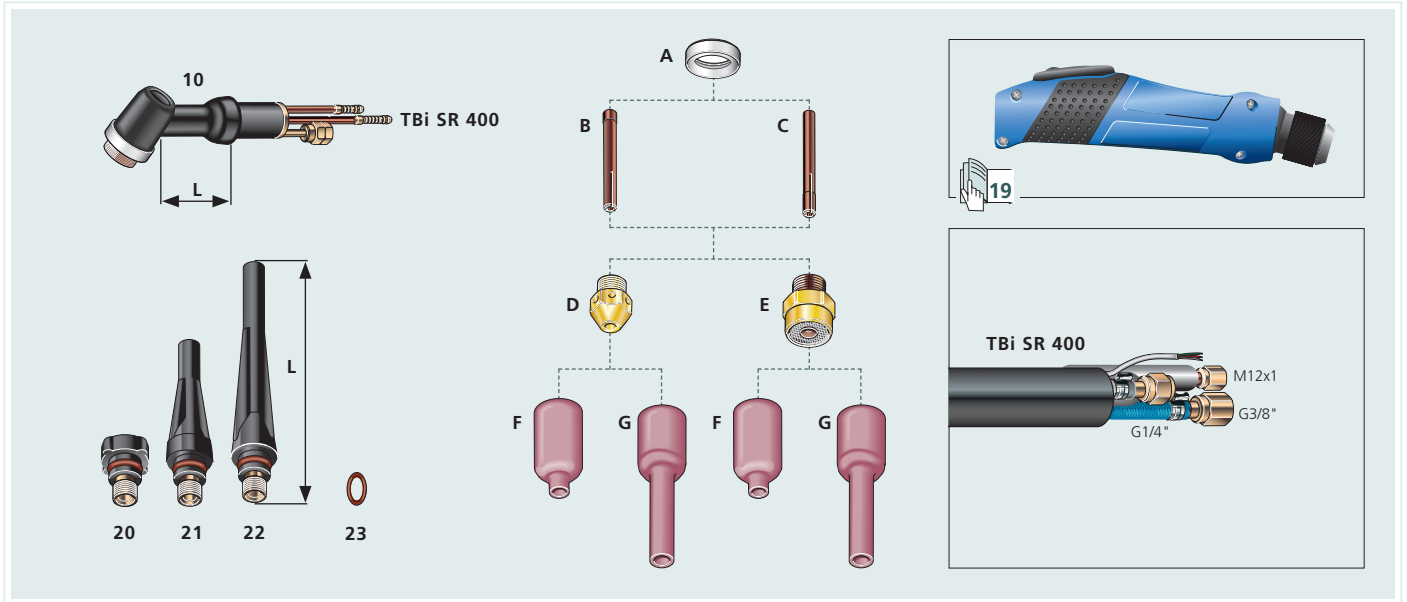

Ersatzteile / Spare parts / Pièces de rechange

10	Brennerkörper / Torch body / Corps de torche	SR 400	L = 50 mm	405P400802
20	Brennerkappe / Back cap / Coiffe	kurz / short / courte	L = 24 mm	57Y04 402P170100
21	Brennerkappe / Back cap / Coiffe	mittel / medium / moyenne	L = 58 mm	57Y05 402P170150
22	Brennerkappe / Back cap / Coiffe	lang / long / longue	L = 140 mm	57Y02 402P170200
23	O-Ring / O-Ring / Joint torique			98W18 365P200096
A	Isolator / Insulator / Isolateur			18NG 405P400001

	Ø 1.0 mm Ø 0.040"	Ø 1.6 mm Ø 1/16"	Ø 2.4 mm Ø 3/32"	Ø 3.2 mm Ø 1/8"	Ø 4.0 mm Ø 5/32"	Ø 4.8 mm Ø 3/16"
--	----------------------	---------------------	---------------------	--------------------	---------------------	---------------------

Spannhülse / Collet / Pincas étou

▶ B	Standard, L=50 mm	10N22 402P170500	10N23 402P170502	10N24 402P170503	10N25 402P170504	54N20 402P170505	-
C	Heavy duty, L=50 mm	-	-	-	405P400504	54N20HD 405P400505	18C36 405P400506

Spannhülsegehäuse / Collet body / Supports pince

▶ D	L=19.5 mm	Ø 1.0-3.2 mm 405P401000		Ø 3.2-4.8 mm 405P401001		
-----	-----------	----------------------------	--	----------------------------	--	--

Gaslinsen / Gas lens / Diffuseurs gaz

E	L=21.3 mm	18GL04 405P401301	18GL16 405P401302	18GL32 405P401303	18GL18 405P401304	18GL53 405P401305	18GL36 405P401306
---	-----------	----------------------	----------------------	----------------------	----------------------	----------------------	----------------------

	No. 4 Ø 6.5 mm Ø 1/4"	No. 5 Ø 8.0 mm Ø 5/16"	No. 6 Ø 9.5 mm Ø 3/8"	No. 7 Ø 11 mm Ø 7/16"	No. 8 Ø 12.5 mm Ø 1/2"	No. 11 Ø 17.5 mm Ø 11/16"
--	-----------------------------	------------------------------	-----------------------------	-----------------------------	------------------------------	---------------------------------

Keramische Gasdüsen / Ceramic nozzles / Buses gaz céramiques

▶ F	Standard, L=42.0 mm	54N18 401P222200	54N17 401P222201	54N16 401P222202	54N15 401P222203	54N14 401P222204	54N19 401P222206
G	Standard, L, L=76.0 mm	54N18 L 401P222211	54N17 L 401P222207	54N16 L 401P222208	54N15 L 401P222209	54N14 L 401P222210	-

▶ = Standard

TBi XCT 400W



TBi XCT 400W
 wassergekühlt /
 water cooled / refroidissement par eau
 100% (10 min.)
 AC: 315 A
 DC: 450 A
 Ø 2.4-4.0 mm

TBi XCT 400W

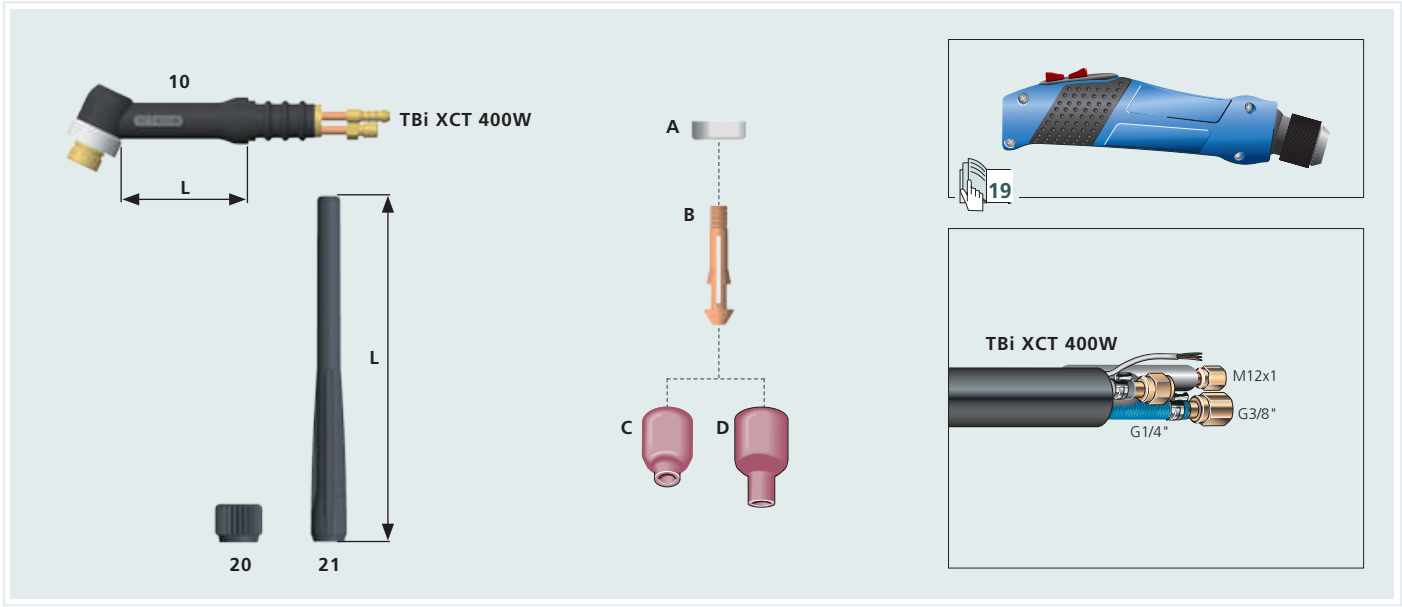

Ersatzteile / Spare parts / Pièces de rechange

10	Brennerkörper / Torch body / Corps de torche	XCT 400W	L = 52 mm	405PX40700
20	Brennerkappe / Back cap / Coiffe	kurz / short / courte	L = 13 mm	402PX40600
21	Brennerkappe / Back cap / Coiffe	lang / long / longue	L = 145 mm	402PX40700
A	Isolator / Insulator / Isolateur			401PX40700

	Ø 2.4 mm Ø 3/32"	Ø 3.2 mm Ø 1/8"	Ø 4.0 mm Ø 5/32"
--	---------------------	--------------------	---------------------

Spannhülse / Collet / Pincés étou

▶ B	L=44.0 mm	-	401PX40502	-	401PX40503	-	401PX40504
-----	-----------	---	------------	---	------------	---	------------

	No. 4 Ø 6.5 mm Ø 1/4"	No. 5 Ø 8.0 mm Ø 5/16"	No. 6 Ø 9.5 mm Ø 3/8"	No. 7 Ø 11 mm Ø 7/16"	No. 8 Ø 12.5 mm Ø 1/2"
--	-----------------------------	------------------------------	-----------------------------	-----------------------------	------------------------------

Keramische Gasdüsen / Ceramic nozzles / Buses gaz céramiques

▶ C	L=25.5 mm	53N58 401P201400	53N59 401P201401	53N60 401P201402	53N61 401P201403	53N61S 401P201404
▶ D	L, L=35.0 mm	53N58L 401P201408	53N59L 401P201405	53N60L 401P201406	53N61L 401P201407	-

▶ = Standard



Griffe und Module / Handles and modules / Poignées et modules

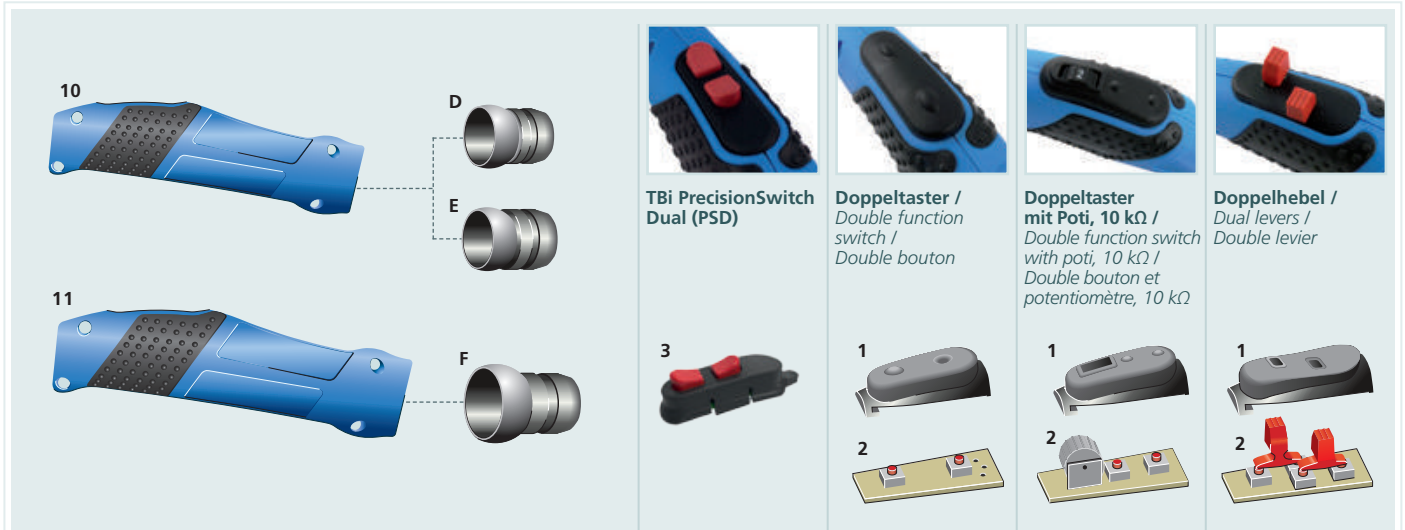

Module / Modules / Modules

1	Gummiabdeckung / Cover / Coiffe	-	401P102022	401P102023	401P102038
2	Platine / PC-Board / Platine	-	384P101034	384P101035	384P101050
3	PSD Modul kpl. / PSD module cpl. / Module PSD cpl.	401P101090	-	-	-

Griff inkl. PSD Modul / Handle incl. PSD / Poignée avec PSD

10	Griffschale klein, nur als Ersatz für Brenner mit PSD/ handle small, replacement for torches with PSD only/ petite poignée, seulement remplacement pour torches avec PSD SR 9, SR 17, SR 20, SR 21, SR 24, XCT 400W	401P101012	-	-	-
11	Griffschale groß, nur als Ersatz für Brenner mit PSD/ handle large, replacement for torches with PSD only/ grande poignée, seulement remplacement pour torches avec PSD SR 18, SR 26, SR 400, AW 424	401P101512	-	-	-

Griff inkl. Modul / Handle incl. module / Poignée avec module

10	Griffschale klein / handle small / petite poignée SR 9, SR 17, SR 20, SR 21, SR 24, SR 25	-	401P101010	401P101020	401P101030
11	Griffschale groß / handle large / grande poignée SR 18, SR 26, SR 400, AW 424, AW 427	-	401P101510	401P101520	401P101530

Ersatzteile / Spare parts / Pièces de rechange

D	Kugelknickschutz / Ball joint / Rotule	SR 9, 17, 24 G, 25 G	401P102026
E	Kugelknickschutz / Ball joint / Rotule	SR 20, 21, 24 W, 25 W	401P102029
F	Kugelknickschutz / Ball joint / Rotule	SR 18, 26, 400, AW 424, 427	401P102032

Brennerhülse und Ausrüstung 10-17 / Torch bodys and equipment / Corps de torche et équipement

TBi SR 12



TBi SR 12

wassergekühlt /
water cooled / refroidissement par eau

100% (10 min.)
AC: 350 A
DC: 500 A
Ø 2.4-6.4 mm

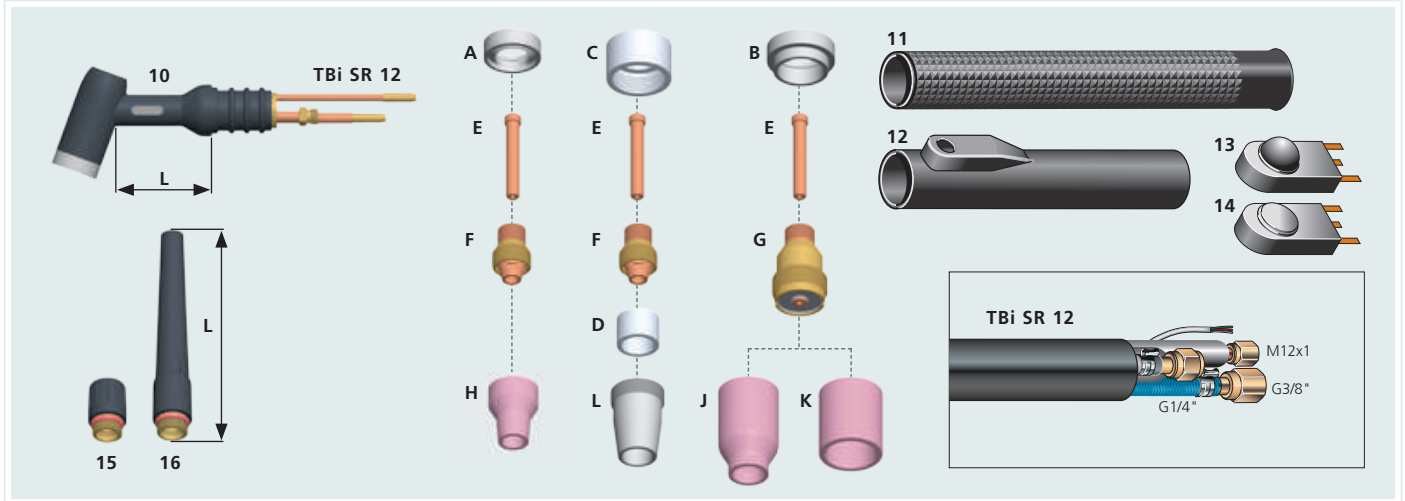

Ersatzteile / Spare parts / Pièces de rechange

10	Brennerkörper / Torch body / Corps de torche	SR 12	L = 60 mm		405P120800
11	Griffrohr / Handle tube / Poignée tube			85WP13	405P120900
12	Schaltermuffe / Switch boot / Housse de poignée				401P120600
13	Schalter / Switch / Micro rupteur	rund / round / rond			385P033009
14	Schalter / Switch / Micro rupteur	flach / flat / flat (Crouzet)			385P233009
15	Brennerkappe / Back cap / Coiffe	kurz / short / courte	L = 31 mm	56Y45	405P120100
16	Brennerkappe / Back cap / Coiffe	lang / long / longue	L = 115 mm	56Y44	405P120200
▶ A	Isolator / Insulator / Isolateur	Standard		12NG	405P120300
B	Isolator / Insulator / Isolateur	Gaslinse / Gas lens / Diffuseur gaz		12GLG	405P120301
C	Isolator / Insulator / Isolateur	Metallische Gasdüse / Metal nozzle / Buse métallique		12MNG	405P120302
D	Isolierhülse / Insulating sleeve / Tube isolante			85Z99	405P120303

	Ø 2.4 mm Ø 3/32"	Ø 3.2 mm Ø 1/8"	Ø 4.0 mm Ø 5/32"	Ø 4.8 mm Ø 3/16"	Ø 6.4 mm Ø 1/4"
--	---------------------	--------------------	---------------------	---------------------	--------------------

Spannhülse / Collet / Pincés étou

▶ E	L=60,2 mm	85Z15 405P120502	85Z16 405P120503	85Z17 405P120504	85Z18 405P120505	85Z19 405P120506
-----	-----------	---------------------	---------------------	---------------------	---------------------	---------------------

Spannhülsegehäuse / Collet body / Supports pince

▶ F	Ø 2.4-6.4 mm 11WP65, 405P121000				
-----	------------------------------------	--	--	--	--

Gaslinsen / Gas lens / Diffuseurs gaz

G	11GL32 405P121302	11GL18 405P121303	11GL53 405P121304	11GL36 405P121305	- 405P121306
---	----------------------	----------------------	----------------------	----------------------	-----------------

	No. 4 Ø 6.5 mm Ø 1/4"	No. 5 Ø 8.0 mm Ø 5/16"	No. 6 Ø 9.5 mm Ø 3/8"	No. 7 Ø 11 mm Ø 7/16"	No. 8 Ø 12.5 mm Ø 1/2"	No. 10 Ø 16 mm Ø 5/8"	No. 12 Ø 19 mm Ø 3/4"	Ø 24 mm
--	-----------------------------	------------------------------	-----------------------------	-----------------------------	------------------------------	-----------------------------	-----------------------------	---------

Keramische Gasdüsen / Ceramic nozzles / Buses gaz céramiques

▶ H	Standard, L=32.0 mm	14N57 401P101700	14N58 401P101701	14N59 401P101702	14N60 401P101703	14N61 401P101704	-	-	-
J	Jumbo Gas lens L=48.0 mm	-	-	57N75 401P201451	-	57N74 401P201452	53N88 401P222250	53N87 401P222251	53N89-L 401P222253
K	Jumbo Gas lens (short), L=34.0 mm	-	-	-	-	-	-	-	53N89 401P222252

Metallische Gasdüsen / Metal nozzles / Buses gaz métalliques

L	Standard, L=40.7 mm	-	-	86Z01 405P120700	-	86Z02 405P120701	86Z03 405P120702	86Z06 405P120703	-
---	------------------------	---	---	---------------------	---	---------------------	---------------------	---------------------	---

▶ = Standard

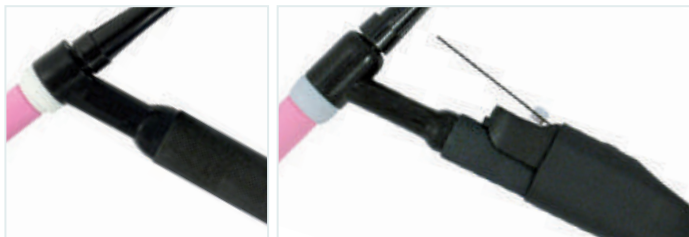

Griffrohre und Schalter / Handle tubes and switches / Poignées tubulaires et gâchettes

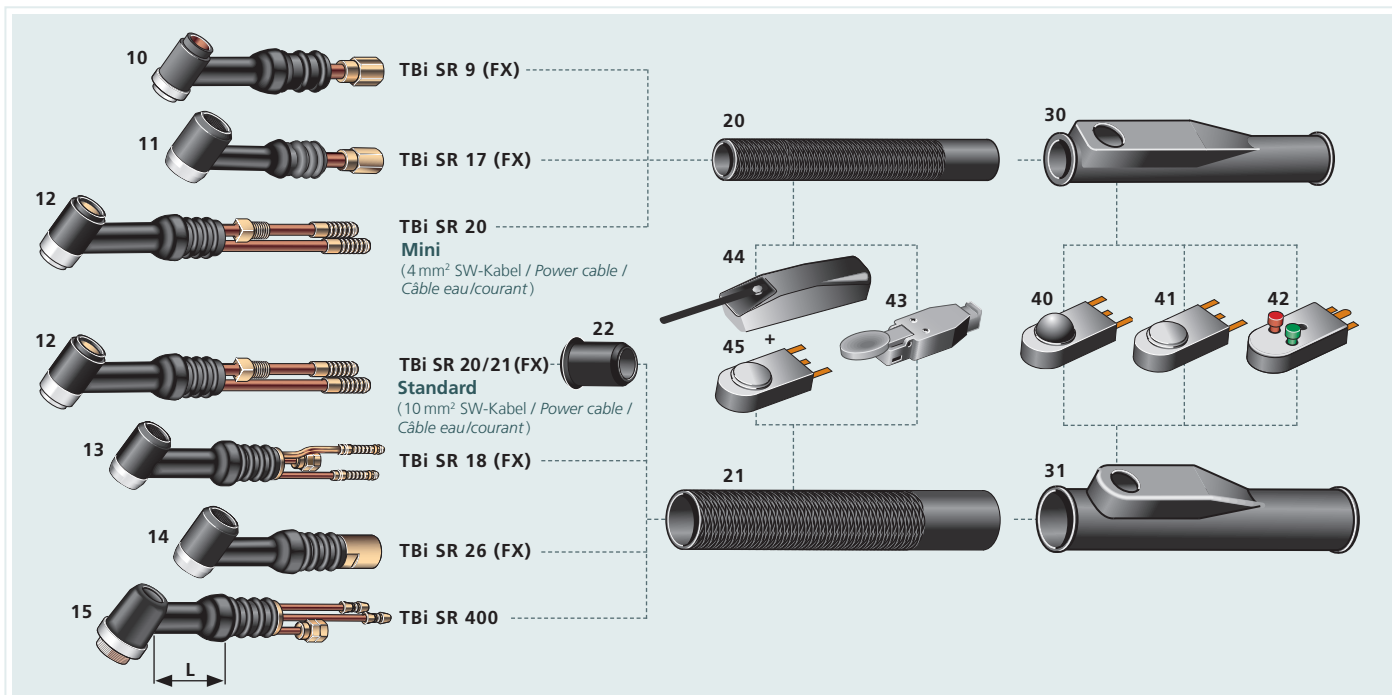

Ersatzteile / Spare parts / Pièces de rechange

10	Brennerkörper / Torch body / Corps de torche	SR 9		L = 35 mm	405P090800
10	Brennerkörper / Torch body / Corps de torche	SR 9 FX	flexibel / flexible / flexible	L = 35 mm	403P090800
11	Brennerkörper / Torch body / Corps de torche	SR 17		L = 50 mm	405P170700
11	Brennerkörper / Torch body / Corps de torche	SR 17 FX	flexibel / flexible / flexible	L = 50 mm	403P170700
12	Brennerkörper / Torch body / Corps de torche	SR 20		L = 35 mm	405P200800
12	Brennerkörper / Torch body / Corps de torche	SR 20 FX	flexibel / flexible / flexible	L = 35 mm	403P200700
12	Brennerkörper / Torch body / Corps de torche	SR 21		L = 35 mm	405P210800
12	Brennerkörper / Torch body / Corps de torche	SR 21 FX	flexibel / flexible / flexible	L = 65 mm	403P210700
12	Brennerkörper / Torch body / Corps de torche	SR 21 FX-L	flexibel / flexible / flexible	L = 115 mm	403P210701
13	Brennerkörper / Torch body / Corps de torche	SR 18		L = 55 mm	405P180700*
13	Brennerkörper / Torch body / Corps de torche	SR 18 FX	flexibel / flexible / flexible	L = 55 mm	403P180700*
14	Brennerkörper / Torch body / Corps de torche	SR 26		L = 50 mm	405P260700*
14	Brennerkörper / Torch body / Corps de torche	SR 26 FX	flexibel / flexible / flexible	L = 50 mm	403P260700*
15	Brennerkörper / Torch body / Corps de torche	SR 400		L = 50 mm	405P400800*

Griffrohre / Handle tubes / Poignées tubulaires

20	Griffrohr / Handle tube / Poignée tubulaire	SR 9, SR 17, SR 20 Mini	D=20,5 mm / L= 130 mm	H 100	402P171301
21	Griffrohr / Handle tube / Poignée tubulaire	SR 18, SR 20 Std., SR 26, SR 400	D=27,5 mm / L= 154 mm	H 200	402P180801
22	Einsatzbuchse / Front insert / Filière	SR 20 Std.			401P201360

Schaltermuffen / Switch boots / Manchon caoutchouc

30	Schaltermuffe / Switch boot / Manchon caoutchouc	SR 9, SR 17, SR 20 Mini		BS-1	401P170600
31	Schaltermuffe / Switch boot / Manchon caoutchouc	SR 18, SR 20 Std., SR 26, SR 400,		BL-1	402P180600

Schalter / Switches / Gâchettes

40	Schalter / Switch / Micro rupteur	rund / round / rond	SW-1	385P033009
41	Schalter / Switch / Micro rupteur	flach / flat / plat	SW-1	385P133009
42	Doppeldruckschalter / Double function switch / Micro rupteur double commande	rot, grün / red, green / rouge, vert		385P033014
43	Löffelschalter / Spoon switch / Gâchette cuillère			385P120002
44	Lamellenschalter / Blade switch / Gâchette à lamelle			402P101002
45	Schalter Crouzet / Crouzet switch / Micro rupteur Crouzet	flach / flat / plat long life	SW-1	385P233009

* Nicht passend zu Tbi Precision Griff / Not compatible with Tbi Precision handle / Pas compatible avec poignée Tbi Precision

Griffrohre / Handle tubes / Poignées tubulaires

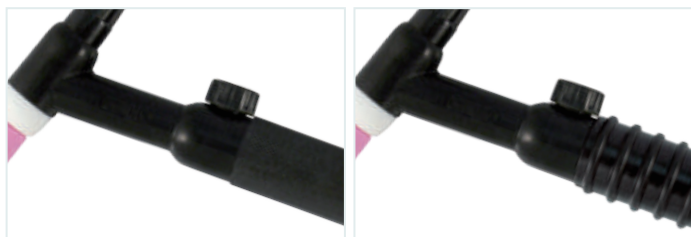

Griffrohre für Ventiltorch / Handle tubes for torch bodies with valve / Poignées pour version à valve

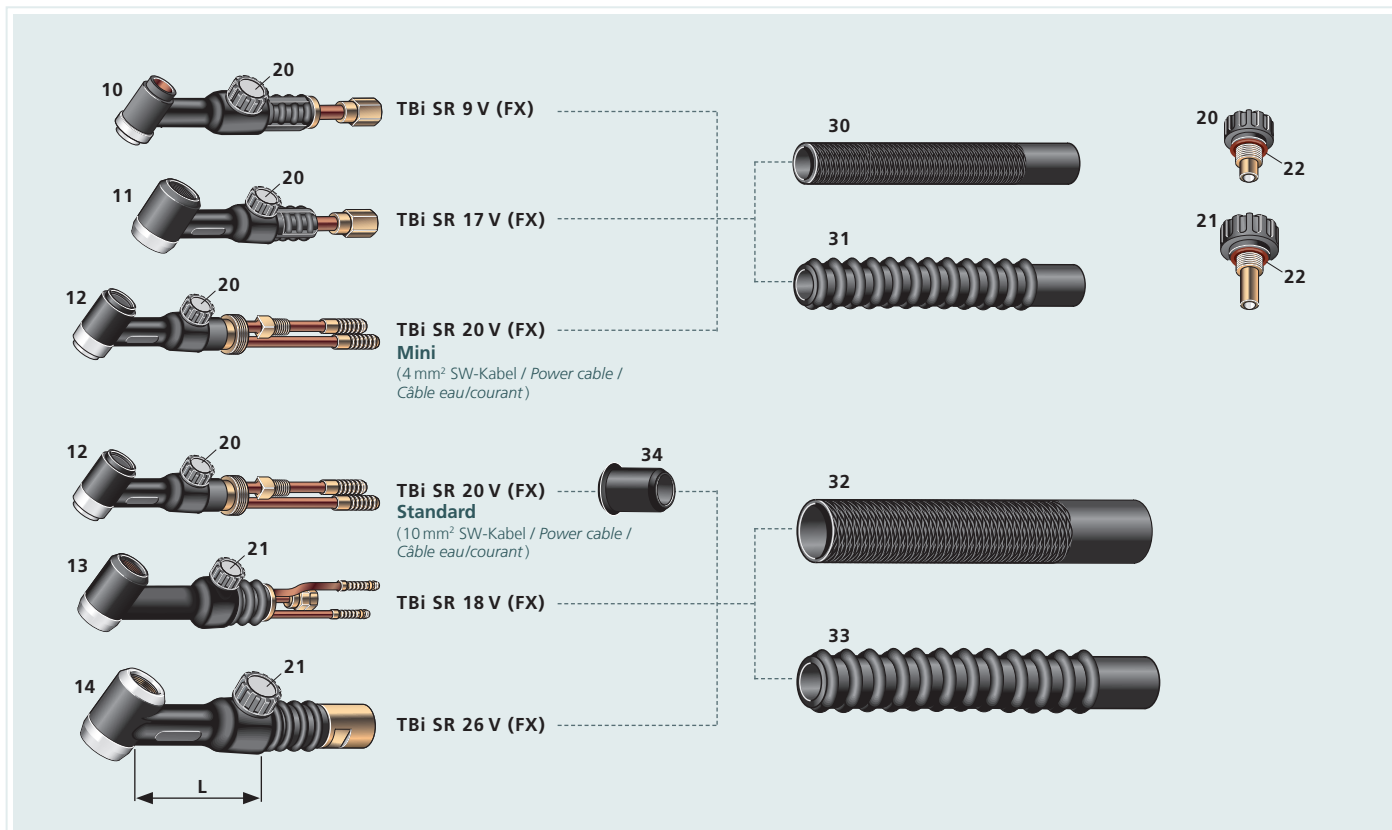

Ersatzteile / Spare parts / Pièces de rechange

10	Brennerkörper / Torch body / Corps de torche	SR 9 V		L= 50 mm	405P090850
10	Brennerkörper / Torch body / Corps de torche	SR 9 V FX	flexibel / flexible / flexible	L= 50 mm	403P090900
11	Brennerkörper / Torch body / Corps de torche	SR 17 V		L= 50 mm	405P170800
11	Brennerkörper / Torch body / Corps de torche	SR 17 V FX	flexibel / flexible / flexible	L= 50 mm	403P170800
12	Brennerkörper / Torch body / Corps de torche	SR 20 V		L= 50 mm	405P200850
12	Brennerkörper / Torch body / Corps de torche	SR 20 V FX	flexibel / flexible / flexible	L= 50 mm	403P200900
13	Brennerkörper / Torch body / Corps de torche	SR 18 V		L= 70 mm	405P180750
13	Brennerkörper / Torch body / Corps de torche	SR 18 V FX	flexibel / flexible / flexible	L= 65 mm	403P180800
14	Brennerkörper / Torch body / Corps de torche	SR 26 V		L= 65 mm	405P260800
14	Brennerkörper / Torch body / Corps de torche	SR 26 V FX	flexibel / flexible / flexible	L= 65 mm	403P260800
20	Ventil / Valve / Valve	SR 9 V, SR 17 V, SR 20 V			405P172400
21	Ventil / Valve / Valve	SR 18 V, SR 26 V			405P262400
22	O-Ring / O-Ring / Joint torique				365P018047

Griffrohre / Handle tubes / Poignées tubulaires

▶ 30	Griffrohr glatt / Handle smooth / Poignée lisse	SR 9 V, SR 17 V, SR 20 V Mini	D=20,5 mm / L=130 mm	H 100	402P171301
31	Griffrohr gerippt / Handle ribbed / Poignée côtelée	SR 9 V, SR 17 V, SR 20 V Mini	D=20,5 mm / L=130 mm	H 100R	402P179264
▶ 32	Griffrohr glatt / Handle smooth / Poignée lisse	SR 18 V, SR 20 V Std., SR 26 V	D=27,5 mm / L=154 mm	H 200	402P180801
33	Griffrohr gerippt / Handle ribbed / Poignée côtelée	SR 18 V, SR 20 V Std., SR 26 V	D=27,5 mm / L=154 mm	H 200R	405P260801
34	Einsatzbuchse / Front insert / Filière	SR 20 V Std.	D=21,5 mm / L=27 mm		401P201360

Ausrüstung 11-17 / Equipment / Equipement

▶ = Standard

Automatenbrenner / Machine Torches / Torches automatiques



TBi SR 9 P (Aut)

Gasgekühlt /
gas cooled / refroidissement par air
60% (10 min.)
AC: 80 A
DC: 110 A
Ø 0.5-1.6 mm



TBi SR 18 P (Aut)

wassergekühlt /
water cooled / refroidissement par eau
100% (10 min.)
AC: 225 A
DC: 320 A
Ø 0.5-4.0 mm

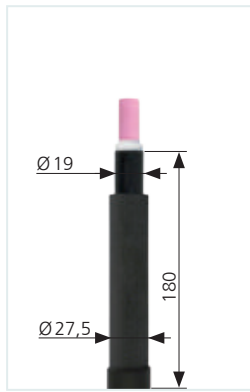

**TBi SR 20 P (Aut)
Standard (10 mm²)**

wassergekühlt /
water cooled / refroidissement par eau
100% (10 min.)
AC: 160 A
DC: 220 A
Ø 0.5-3.2 mm



**TBi SR 20 P (Aut)
Mini (4 mm²)**

wassergekühlt /
water cooled / refroidissement par eau
100% (10 min.)
AC: 105 A
DC: 140 A
Ø 0.5-3.2 mm



TBi SR 26 P (Aut)

Gasgekühlt /
gas cooled / refroidissement par air
60% (10 min.)
AC: 170 A
DC: 240 A
Ø 0.5-4.0 mm

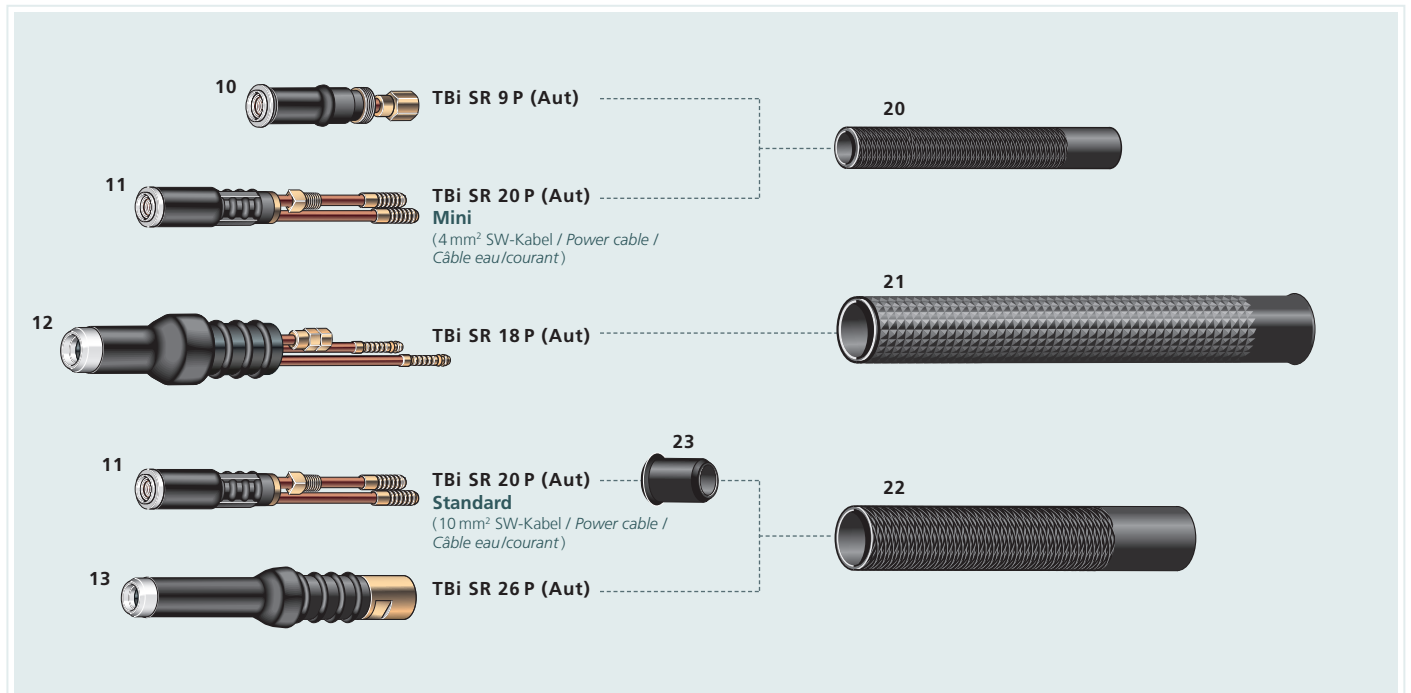

Ersatzteile / Spare parts / Pièces de rechange

10	Brennerkörper / Torch body / Corps de torche	SR 9 P (Aut)	405P090900
11	Brennerkörper / Torch body / Corps de torche	SR 20 P (Aut)	491P200001
12	Brennerkörper / Torch body / Corps de torche	SR 18 P (Aut)	491P180001
13	Brennerkörper / Torch body / Corps de torche	SR 26 P (Aut)	405P260900

Griffrohre / Handle tube / Poignée tubulaires

▶ 20	Griffrohr / Handle tube / Poignée tubulaire	SR 9 P (Aut), SR 20 P (Aut) Mini	D=20,5 mm / L=130 mm	402P171301
21	Griffrohr / Handle tube / Poignée tubulaire	SR 18 P (Aut)	D=35 mm / L=250 mm	491P180800
▶ 22	Griffrohr / Handle tube / Poignée tubulaire	SR 26 P (Aut), SR 20 P (Aut) Std.	D=27,5 mm / L=154 mm	402P180801
23	Einsatzbuchse / Front insert / Filière	SR 20 P (Aut) Std.	D=21,5 mm / L=27 mm	401P201360

Ausrüstung 11+13 / Equipment / Equipement

▶ = Standard

Ausrüstkits / Consumables kit / Kits équipement



Ausrüstkits für TBI WIG Brenner /
Consumable kits for TBI TIG torches /
Kits équipement pour torches TIG TBI

für / for / pour

TBi SR 9, TBi SR 20, TBi SR 21

für Elektrode / for electrode / pour électrode	Std. Kit für / Std. Kit for / Kit std. pour	Art. Nummer / Part. no. / No. d'article
Ø 1.0 mm	-	401P200400
Ø 1.6 mm	TBi SR 9	401P200401
Ø 2.4 mm	TBi SR 20 TBi SR 21	401P200402
Ø 3.2 mm	-	401P200403

Inhalt der Kits / Content of the kits / Contenu des kits

				
Standard, L=30.0 mm	Standard, L=20.6 mm	Standard, L=25.4 mm		
No. 5 Ø 8.0 mm / 5/16"	401P201107	401P201000	401P200600	401P200300
No. 6 Ø 9.5 mm / 3/8"	401P201108	401P201001	401P200601	401P200300
No. 7 Ø 11.0 mm / 7/16"	401P201109	401P201002	401P200602	401P200300
No. 8 Ø 12.5 mm / 1/2"	401P201110	401P201003	401P200603	401P200300

für / for / pour

TBi SR 17, TBi SR 18, TBi SR 26

für Elektrode / for electrode / pour électrode	Std. Kit für / Std. Kit for / Kit std. pour	Art. Nummer / Part. no. / No. d'article
Ø 1.0 mm	-	402P170400
Ø 1.6 mm	TBi SR 17	402P170401
Ø 2.4 mm	TBi SR 18 TBi SR 26	402P170402
Ø 3.2 mm	-	402P170403
Ø 4.0 mm	-	402P170404

Inhalt der Kits / Content of the kits / Contenu des kits

				
Standard, L=47.0 mm	Standard, L=47.0 mm	Standard, L=50.0 mm		
No. 4 Ø 6.5 mm / 1/4"	401P170907	401P180998	402P170500	402P170200
No. 5 Ø 8.0 mm / 5/16"	401P170908	401P180999	402P170502	402P170200
No. 6 Ø 9.5 mm / 3/8"	401P170909	401P181000	402P170503	402P170200
No. 7 Ø 11.0 mm / 7/16"	401P170910	401P181001	402P170504	402P170200
No. 8 Ø 12.5 mm / 1/2"	401P170911	401P181002	402P170505	402P170200

Ready for Tomorrow.

© 2015 TBi Industries GmbH. Alle Rechte vorbehalten. Technische Änderungen vorbehalten. Kopie oder Nachdruck auch auszugsweise nicht gestattet. / *All rights reserved. Subject to change without notice. Excerpts and reprints not permitted.* / *Tous droits réservés. Sous réserve de modifications techniques. Copie/reproduction même partielle non autorisée.* Nr. DOKP12101C, 03/2015.

TBi Industries GmbH
Ruhberg 14
D-35463 Fernwald-Steinbach
Postfach 67
D-35461 Fernwald-Steinbach

Tel. + 49 6404 9171-0
Fax. + 49 6404 9171-58
Internet: www.tbi-industries.com
E-mail: info@tbi-industries.com